

- 1 **IL QUARTO STATO** | THE FOURTH ESTATE
- 2 **IL MUSEO DEL NOVECENTO. UN NUOVO RACCONTO** | MUSEO DEL NOVECENTO. A NEW NARRATIVE
- 3 **FANTASMAGORIA FUTURISTA** | FUTURIST PHANTASMAGORIA
- 4 **FUTURISMO** | FUTURISM
- 5 **VALORI PLASTICI** | PLASTIC VALUES
- 6 **MEMORIE DEL PASSATO** | MEMORIES OF THE PAST
- 7 **ARCAISMI** | ARCHAISMS
- 8 **L'ARTE TRAGICA E SENZA TEMPO DEGLI ANNI DEL FASCISMO** | THE TRAGIC AND TIMELESS ART OF THE FASCIST ERA
- 9 **GIORGIO MORANDI** | GIORGIO MORANDI
- 10 **ARIA DI PARIGI** | PARIS ATMOSPHERE
- 11 **DUE STRADE DELL'ASTRATTISMO** | TWO PATHS FOR ABSTRACT ART
- 12 **GEOMETRIE E SENTIMENTO** | GEOMETRIES AND SENSIBILITY
- 13 **COLLEZIONE MARINO MARINI** | MARINO MARINI COLLECTION
- 14 **LUCIO FONTANA** | LUCIO FONTANA
- 15 **MILITANZE A CONFRONTO** | COMPARING ACTIVIST MOVEMENTS
- 16 **CORRENTE, PICASSISMO, NEOCUBISMO** | CORRENTE, PICASSISM, NEO-CUBISM
- 17 **VERSO L'ASSOLUTO** | TOWARDS THE ABSOLUTE
- 18 **ALBERTO BURRI** | ALBERTO BURRI
- 19 **NUOVE VIE DELL'ASTRAZIONE** | ABSTRACT ART
- 20 **FESTA CINESE** | CHINESE FESTIVAL
- 21 **ARTE PROGRAMMATA E CINETICA** | PROGRAMMED AND KINETIC ART
- 22 **POP, NEW DADA, NUOVO RACCONTO** | POP, NEW DADA, NEW NARRATIVE
- 23 **POP ART A ROMA** | POP ART IN ROME
- 24 **CAROL RAMA** | CAROL RAMA
- 25 **PITTURA, GEOMETRIE, SUPERFICI** | PAINTING, GEOMETRIES, SURFACES
- 26 **INSTALLAZIONI. SPECCHI, SGUARDI, SPIRALI** | INSTALLATIONS. MIRRORS, LOOKS, SPIRALS
- 27 **LUCIANO FABRO** | LUCIANO FABRO
- 28 **INSTALLAZIONI. SERIE, MATERIE, ARCHETIPI** | INSTALLATIONS. SERIES, MATERIALS, ARCHETYPES
- 29 **IL RACCONTO DI NUOVO** | THE NARRATIVE, AGAIN
- 30 **CONCETTUALE, FOTOGRAFIA, GEOGRAFIE** | CONCEPTUAL, PHOTOGRAPHY, GEOGRAPHY

- ③ **GUARDAROBA** | CLOAKROOM
- ④ **BIGLIETTERIA** | TICKETS
- ⑤ **RISTORANTE E CAFFETERIA** | RESTAURANT AND CAFETERIA
- ⑥ **BAGNI** | TOILETS
- ⑦ **SCALA MOBILE** | ESCALATOR
- ⑧ **ASCENSORE** | ELEVATOR

**MAPPA 3D | 3D MAP**

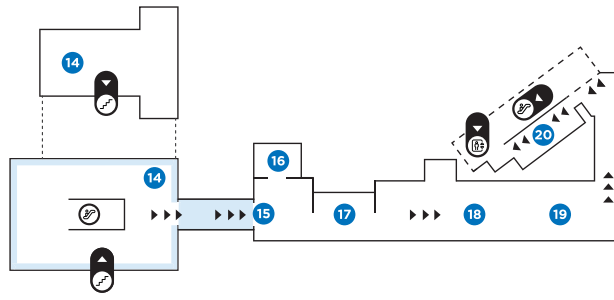
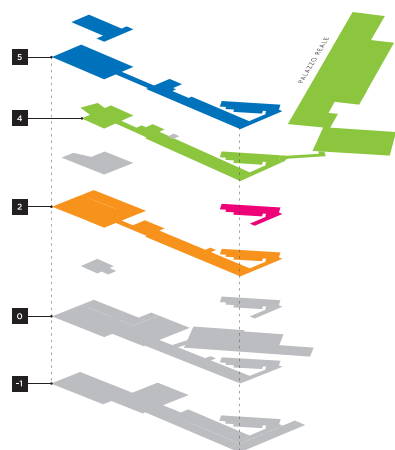

PIANO | FLOOR **5**

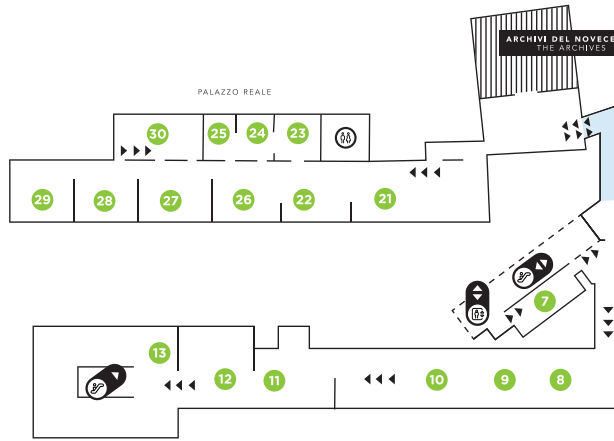

PIANO | FLOOR **4**

**Conclusione del percorso sale 21-30**  
End of exhibition path 21-30 halls

**Continuazione percorso sale 7-13 e sale 14-20 (3 PIANO)**  
Exhibition path 7-13 halls and 14-20 halls (3 floor)

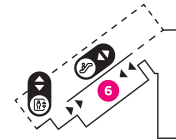
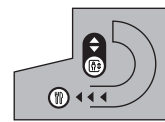

PIANO | FLOOR **3**

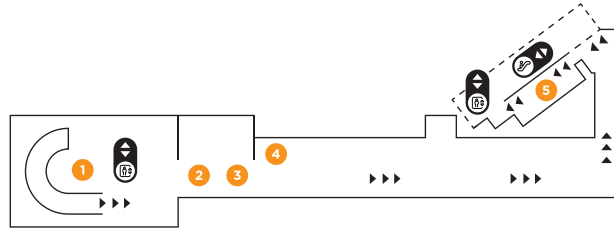

PIANO | FLOOR **2**



PIANO | FLOOR **1**

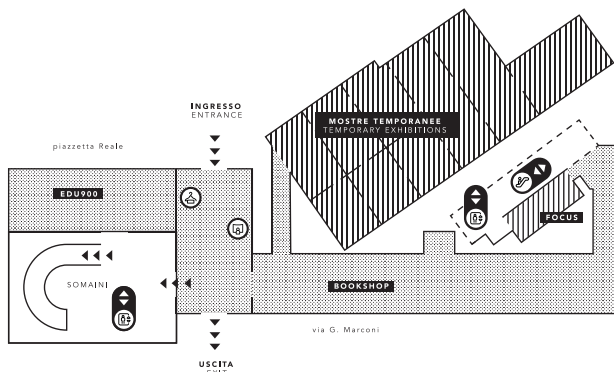

PIANO | FLOOR **0**

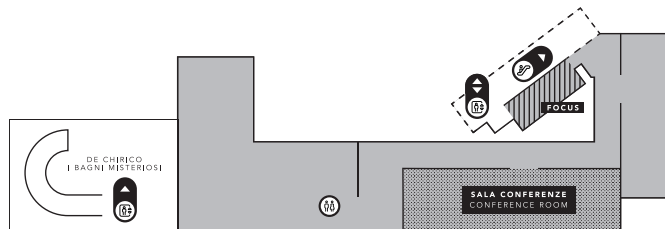

PIANO | FLOOR **-1**